

Small Signal Product

## 225mW SMD Switching Diode

### FEATURES

- Low turn-on voltage
- Fast switching
- PN junction guard ring for transient and ESD protection

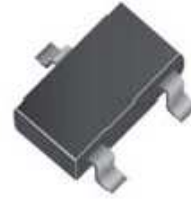

### MECHANICAL DATA

- Case: SOT- 23, molded plastic
- Terminal: Matte tin plated, lead free, solderable per MIL-STD-202, Method 208 guaranteed
- High temperature soldering guaranteed: 260°C/10s
- Weight: 0.008grams (approximately)

**SOT-23**

MAXIMUM RATINGS AND ELECTRICAL CHARACTERISTICS (T <sub>A</sub> =25°C unless otherwise noted)			
PARAMETER	SYMBOL	VALUE	UNIT
Peak Repetitive Reverse Voltage	V <sub>RRM</sub>	70	V
Working Peak Reverse Voltage	V <sub>RWM</sub>		
DC Blocking Voltage	V <sub>R</sub>		
RMS Reverse Voltage	V <sub>R(RMS)</sub>	49	V
Forward Continuous Current (Note 1)	I <sub>F</sub>	70	mA
Non-Repetitive Peak Forward Surge Current @ t ≤ 1.0 s	I <sub>FSM</sub>	100	mA
Power Dissipation (Note 1)	P <sub>D</sub>	200	mW
Thermal Resistance Junction to Ambient Air (Note 1)	R <sub>θJA</sub>	625	K/W
Operating Junction Temperature	T <sub>J</sub>	-55 to + 125	°C
Storage Temperature Range	T <sub>STG</sub>	-55 to + 150	°C

PARAMETER	SYMBOL	MIN	MAX	UNIT
Reverse breakdown voltage I <sub>R</sub> = 10 μA	V <sub>(BR)</sub>	70	-	V
Forward voltage tp=300μs , I <sub>F</sub> =1.0mA tp < 300μs , I <sub>F</sub> =15mA	V <sub>F</sub>	-	410	mV
		-	1000	
Reverse leakage current tp < 300μs , V <sub>R</sub> =50V	I <sub>R</sub>	-	100.00	nA
Junction capacitance V <sub>R</sub> = 0 V, f = 1 MHz	C <sub>J</sub>	-	2	pF
Reverse recovery time I <sub>F</sub> = I <sub>R</sub> = 10 mA, I <sub>RR</sub> = 100 Ω, I <sub>RR</sub> = 1 mA	t <sub>rr</sub>	-	5	ns

Notes: 1. Valid provided that terminals are kept at ambient temperature

2. Test period &lt; 3000 μs

Small Signal Product

**RATINGS AND CHARACTERISTICS CURVES**

(TA=25°C unless otherwise noted)

Fig.1 Power Derating Curve

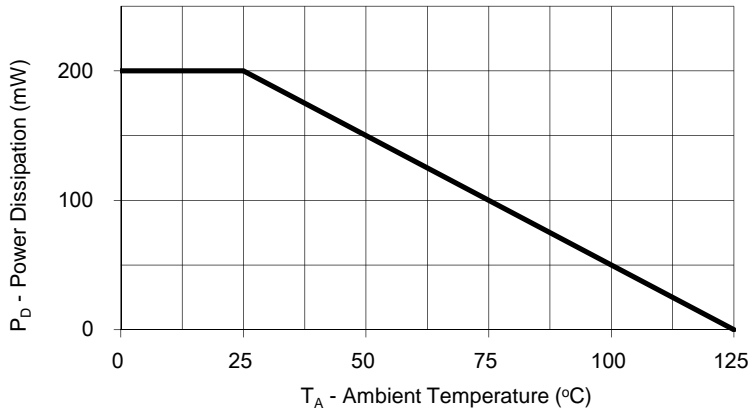

Fig. 2 Maximum Non-Repetitive Peak Forward Surge Current Per Leg

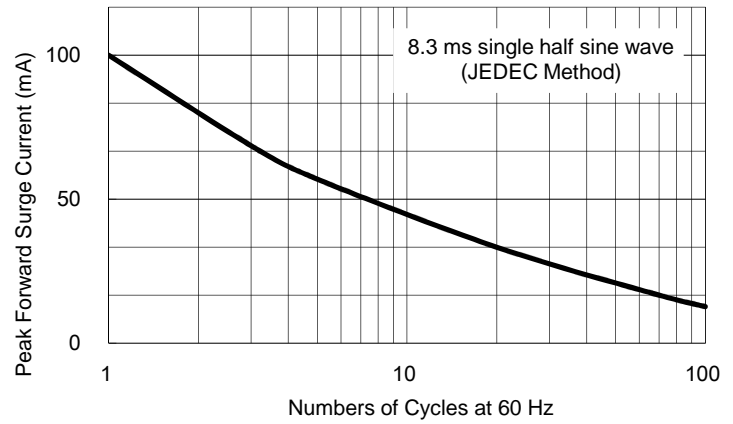

Fig. 3 Typical Forward Characteristics

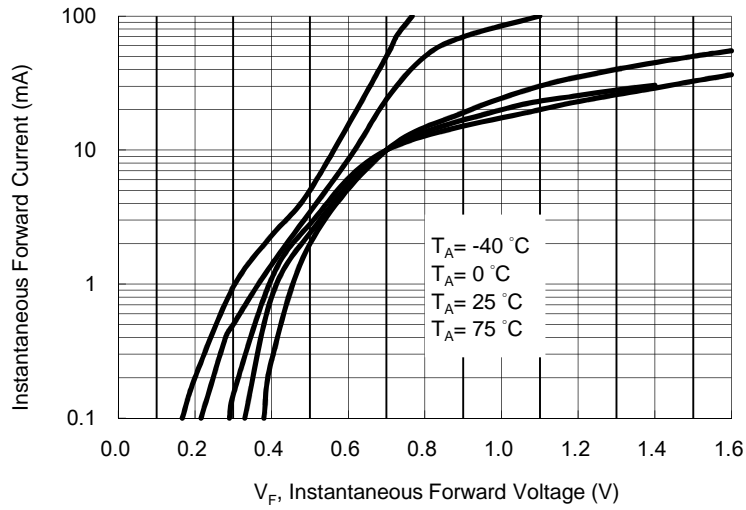

Fig. 4 Typical Reverse Characteristics

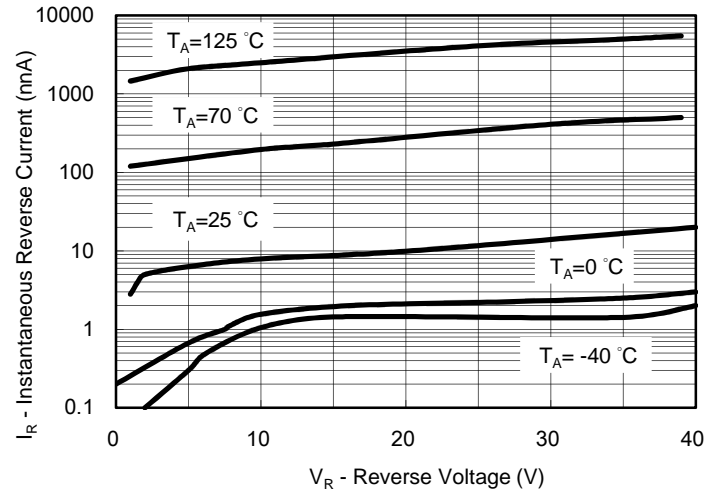

Fig. 5 Typical Total Capacitance VS. Reverse Voltage

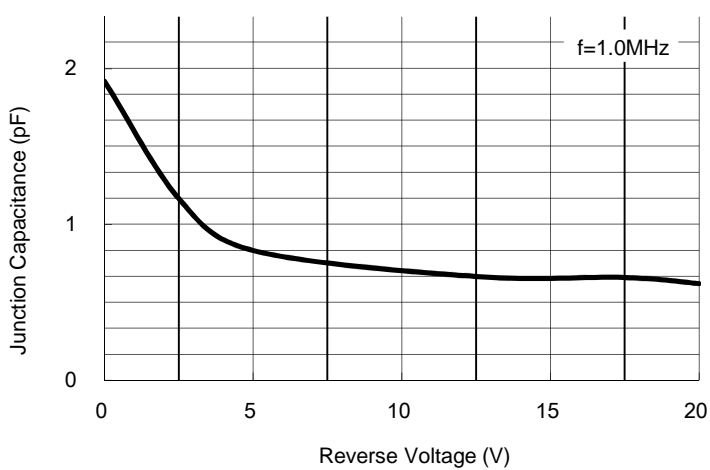
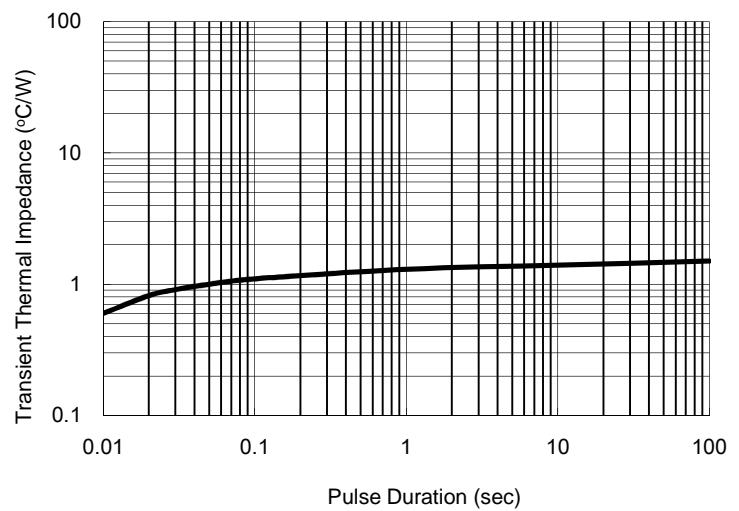

Fig. 6 Typical Transient Thermal Characteristics



Small Signal Product

<b>ORDERING INFORMATION</b>						
<b>PART NO.</b>	<b>MANUFACTURE CODE</b>	<b>PACKING CODE</b>	<b>GREEN COMPOUND CODE</b>	<b>PACKAGE</b>	<b>PACKING</b>	<b>MARKING</b>
BAS70	(Note)	RF	G	SOT-23	3K / 7" Reel	73
BAS70-04		RF	G	SOT-23	3K / 7" Reel	74
BAS70-05		RF	G	SOT-23	3K / 7" Reel	75
BAS70-06		RF	G	SOT-23	3K / 7" Reel	76

Note: Manufacture special control, if empty means no special control requirement.

<b>EXAMPLE</b>					
<b>PREFERRED P/N</b>	<b>PART NO.</b>	<b>MANUFACTURE CODE</b>	<b>PACKING CODE</b>	<b>GREEN COMPOUND CODE</b>	<b>DESCRIPTION</b>
BAS70 RFG	BAS70		RF	G	Green compound
BAS70-B0 RFG	BAS70	B0	RF	G	Green compound
BAS70-D0 RFG	BAS70	D0	RF	G	Green compound

Small Signal Product

**PACKAGE OUTLINE DIMENSIONS**

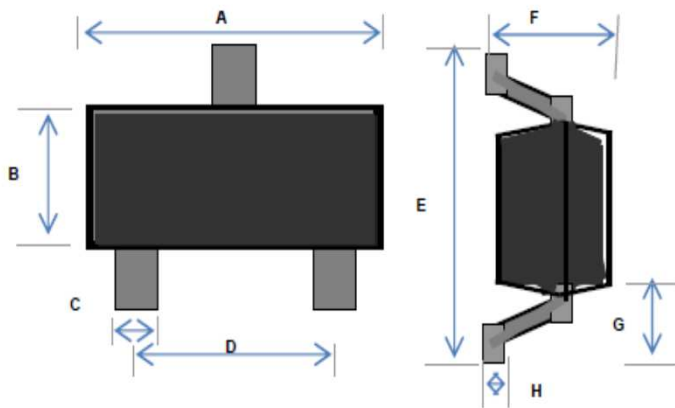

DIM.	Unit (mm)		Unit (inch)	
	Min	Max	Min	Max
A	2.70	3.10	0.106	0.122
B	1.10	1.50	0.043	0.059
C	0.30	0.51	0.012	0.020
D	1.78	2.04	0.070	0.080
E	2.10	2.64	0.083	0.104
F	0.89	1.30	0.035	0.051
G	0.55 REF		0.022 REF	
H	0.1 REF		0.004 REF	

**SUGGEST PAD LAYOUT**

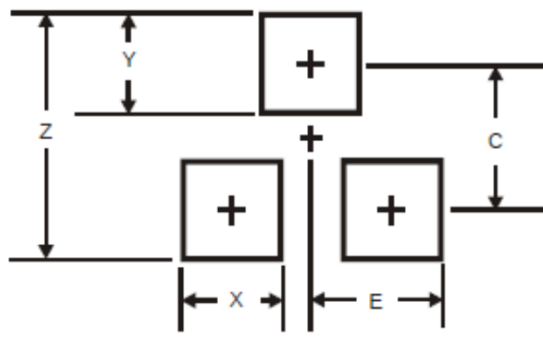

DIM.	Unit (mm)	Unit (inch)
	Typ.	Typ.
Z	2.9	0.114
X	0.8	0.031
Y	0.9	0.035
C	2.0	0.079
E	1.35	0.053

**Pin Configuration**

